



**Abso Sinewave
Inverter-Charger
2000W (IC1220100)
3000W (IC1230150)
4000W (IC244090i)**

Owner's Manual



For safe and optimum performance, the KISAE **Abso Inverter-Charger** must be used properly. Carefully read and follow all instructions and guidelines in this manual and give special attention to the **CAUTION** and **WARNING** statements.

PLEASE KEEP THIS MANUAL FOR FUTURE REFERENCE

Disclaimer

While every precaution has been taken to ensure the accuracy of the contents of this guide, **KISAE Technology** assumes no responsibility for errors or omissions. Note as well that specifications and product functionality may change without notice.

Important

Please be sure to read and save the entire manual before using your **KISAE Inverter-Charger**. Misuse may result in damage to the unit and/or cause harm or serious injury. Read manual in its entirety before using the unit and save manual for future reference.

Product Numbers

IC1230150 *Abso Inverter-Charger 3000 (12V – 120VAC)*
IC1220100 *Abso Inverter-Charger 2000 (12V – 120VAC)*
IC244090i *Abso Inverter-Charger 4000 (24V – 230VAC)*

Document Part Number

MUIC1230 Rev B

Service Contact Information

Email: info@kisaetechnology.com

Phone : 1 877 897-5778

Web : www.kisaetechnology.com

IMPORTANT SAFETY INFORMATION

This section contains important safety information for the unit. Each time, before using the unit, READ ALL instructions and cautionary markings on or provided with the unit, and all appropriate sections of this guide.

The unit contains no user-serviceable parts. See Warranty section for how to handle product issues.

DANGER: Fire and/or Chemical Burn Hazard. Failure to follow these instructions can result in death or serious injury!

- Do not cover or obstruct any air vent openings and/or install in a zero-clearance compartment.
- When working with electrical equipment or lead acid batteries, have someone nearby in case of an emergency.
- Study and follow all the battery manufacturer's specific precautions when installing, using and servicing the battery connected to the inverter unit.
- Wear eye protection and gloves.
- Avoid touching your eyes while using this unit.
- Keep fresh water and soap on hand in the event battery acid comes in contact with eyes. If this occurs, cleanse right away with soap and water for a minimum of 15 minutes and seek medical attention.
- Batteries produce explosive gases. **DO NOT** smoke or have an open spark or fire near the system.
- Keep unit away from moist or damp areas.
- Avoid dropping any metal tool or object on the battery. Doing so could create a spark or short circuit which goes through the battery or another electrical tool that may create an explosion.

DANGER: Shock Hazard. Keep away from children!

- Avoid moisture. Never expose unit to snow, water etc.
- Unit provides household AC, treat the AC output the same as regular wall AC sockets at home.

DANGER: Explosion hazard!

- DO NOT use the unit in the vicinity of flammable fumes or gases (such as propane tanks or large engines).
- AVOID covering the ventilation openings. Always operate unit in an open area.
- Prolonged contact to high heat or freezing temperatures will decrease the working life of the unit.

FCC INFORMATION

This equipment has been tested and found to comply with the limits for a Class B digital device, pursuant to part 15 of the FCC Rules. These limits are designed to provide reasonable protection against harmful interference in a residential installation. This equipment generate, uses and can radiate radio frequency energy and, if not installed and used in accordance with the instructions, may cause harmful interference to radio communications. However, there is no guarantee that interference will not occur in a particular installation. If this equipment does cause harmful interference to radio or television reception, which can be determined by turning the equipment off and on, the user is encouraged to try to correct the interference by one or more of the following measures:

- Reorient or relocate the receiving antenna.
- Increase the separation between the equipment and the receiver.
- Connect the equipment into an outlet on a circuit different from that to which the receiver is connected.
- Consult the dealer or an experienced radio/TV technician for help.

LIMITATIONS ON USE

Do not use in connection with life support systems or other medical equipment or devices.

Table of Contents

1.	INTRODUCTION.....	5
2.	PRODUCT DESCRIPTION	5
3.	INSTALLATION	6
4.	UNIT OPERATION.....	12
5.	FEATURE SETTING.....	15
6.	TROUBLESHOOTING	16
7.	SPECIFICATIONS	17
8.	WARRANTY.....	18

1. INTRODUCTION

Thank you for purchasing the KISAE **Abso Inverter-Charger**. With our state of the art, easy to use design, this product will offer you reliable service by providing AC power for your home, cabin, boat, RV, Caravan or Trailer and recharge your battery automatically when utility AC is available. The unit can run many AC-powered appliances when you need AC power anywhere. The multi-stage battery charger will charge different types of batteries. The transfer switch will automatically switch the load to the battery power when the utility power is interrupted.

Feature Highlights

- The unit provides true sinewave output power for your microwave, entertainment system, computer and other loads. The AC output power is identical to the AC power provided by the utility grid. It can handle sensitive loads such as dimmer switches and appliances with speed controls.
- High surge power to start difficult load like sump pumps, refrigerators, or A/C compressors.
- The battery charger has high output, multi-stage charging capability to minimize charging time. The Power Factor Corrected (PFC) input minimizes AC input current required for charging.
- Optional Battery Temperature Sensor (BTS) is available and used to sense the battery temperature to correct charging voltage to ensure the battery is fully charged.
- A manual Equalization Mode is built-in to improve the life and performance of flooded batteries.
- The charger can charge dead batteries as low as 7 volts on 12V models and 14 volts on 24V models.
- During utility mode, the built-in AC load sensing circuit will automatically reduce charging current if there is a high demand on AC load. This avoids the tripping of the shore circuit breaker.

2. PRODUCT DESCRIPTION

The KISAE Abso Inverter-Charger includes the items list below.

- Inverter-Charger base unit
- Remote Display
- 25 ft (7.6 m) remote display cable
- Owner's manual (P/N: MU IC 1230)

Model	Inverter	Charger
IC1220100	2000W - 120 VAC	12V - 100A
IC1230150	3000W - 120 VAC	12V - 150A
IC244090i	4000W - 230 VAC	24V - 90A

Understanding the unit features

IC1220100

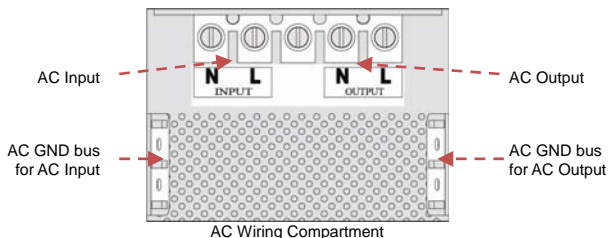
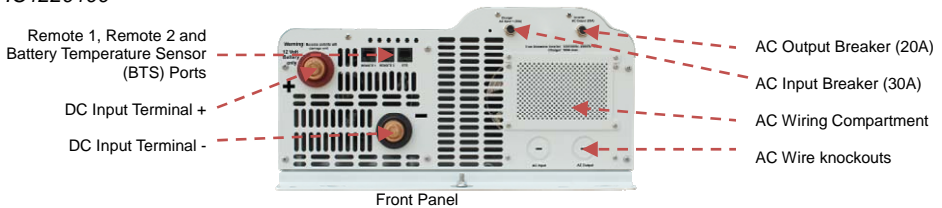

IC1230150

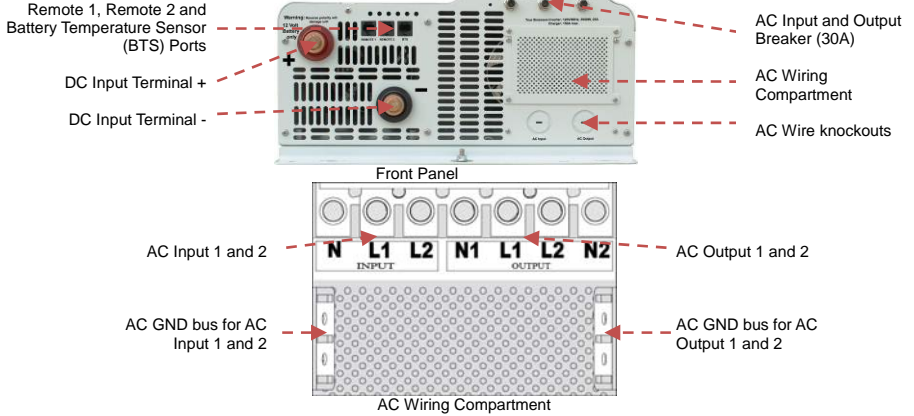

IC244090i

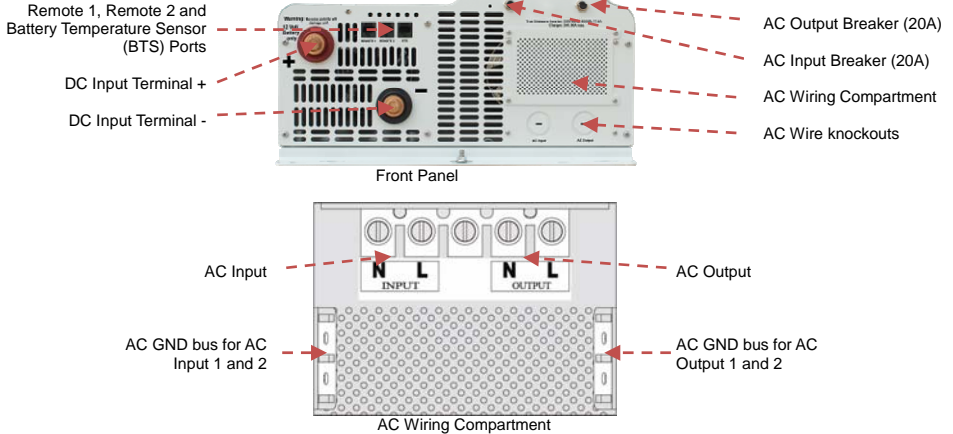

Control Panel

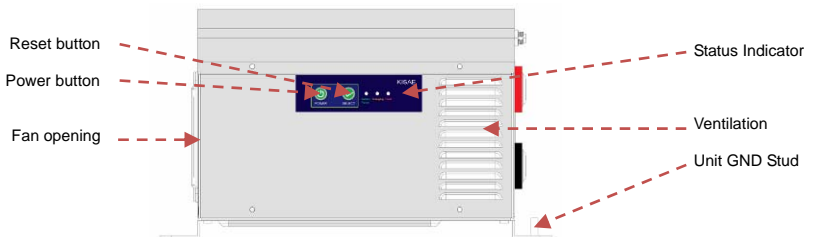

3. INSTALLATION

WARNING: All wiring should be done by a certified technician or electrician to ensure adherence to the applicable electrical safety wiring regulations and installation codes. Failure to follow these instructions can damage the unit and could also result in

personal injury or loss of life.

CAUTION: Before beginning unit installation, please consider the following:

- The unit should be used or stored in an indoor area away from direct sunlight, heat, moisture or conductive contaminants.
- When placing the unit, allow a minimum of three inches of space around the unit for optimal ventilation.

Preparing for Installation

Input AC Source, AC Loads and AC Output Neutral Bonding for IC1220100

Before you begin the installation, be sure to review the Important Safety Instruction on page 3 of this manual and be aware of all safety and electrical codes which must be met in your area.

AC Input of the inverter charger can be supplied a split-phase AC Source. See below to understand more about the unit before you start your installation.

- **Input AC Source:**

A single phase AC Source 1 line, 1 neutral and 1 ground is required.

- **AC Loads:**

In Battery-mode, the unit's AC Output provides 120VAC.

In Pass-Through mode, the AC Source connected to the unit's AC input is passed through to the AC Output (load).

DANGER: Electrical Shock Hazard. Do not connect 240VAC load to the AC Output of the unit.

- **AC Output Neutral Bonding:**

Each AC Source must have its neutral conductor bonded to ground.

When the KISAE Inverter-Charger is running in Battery mode, the internal neutral-to-ground bonding system is enabled. The unit will act as an AC Source and will automatically connect the AC Output Neutral circuit to safety ground.

When the unit is running in Pass-Through mode, the internal neutral-to-ground bonding system is disabled. The unit will not act as an AC Source and the AC Output to safety ground is disconnected inside the unit. Therefore, the AC Input source that is connected to the Inverter-Charger should have its own neutral-to-ground connection. If not, have an electrician look into bonding the AC Source's neutral to ground at your AC Source.

Input AC Source, AC Loads and AC Output Neutral Bonding for IC1230150

Before you begin the installation, be sure to review the Important Safety Instruction on page 3 of this manual and be aware of all safety and electrical codes which must be met in your area.

AC Input of the inverter charger can be supplied from either a split-phase or a dual-input AC Source. See below to understand more about the unit before you start your installation.

- **Input AC Source from Split-Phase:**

The split-phase AC Source has 2 lines, 1 neutral and 1 ground. The two 120Vac lines are 180 degree out of phase with each other with a total of 240Vac when measured from line to line. The voltage between each line to neutral is 120Vac.

- **Input AC Source from Dual Input:**

The dual input has 2 line inputs, 1 neutral and 1 ground. The two 120Vac lines are in phase and must come from the same source.

- **AC Loads:**

In Battery-Inverter mode, the unit's AC Output L1 and L2 lines are connected together to provide 120Vac on both lines.

In Pass-Through mode, the AC Source connected to the unit's AC input is passed through to the AC Output (load).

DANGER: Electrical Shock Hazard. Do not connect 240VAC load to the AC Output of the unit.

- **AC Output Neutral Bonding:**

Each AC Source must have its neutral conductor bonded to ground.

When the KISAE Inverter-Charger is running in Battery-Inverter mode, the internal neutral-to-ground bonding system is enabled. The unit will act as an AC Source and will automatically connect the AC Output Neutral (N1 & N2) circuit to safety ground.

When the unit is running in Pass-Through mode, the internal neutral-to-ground bonding system is disabled. The unit will not act as an AC Source and the AC Output (N1 & N2) to

safety ground is disconnected inside the unit. Therefore, the AC Input source that is connected to the Inverter-Charger should have its own neutral-to-ground connection. If not, have an electrician look into bonding the AC Source's neutral to ground at your AC Source.

Input AC Source, AC Loads for IC244090i

Before you begin the installation, be sure to review the Important Safety Instruction on page 3 of this manual and be aware of all safety and electrical codes which must be met in your area. AC Input of the inverter charger can be supplied a split-phase AC Source. See below to understand more about the unit before you start your installation.

- **Input AC Source:**

A single phase AC Source 1 line, 1 neutral and 1 ground is required.

- **AC Loads:**

In Battery-Inverter mode, the unit's AC Output provides 230VAC.

In Pass-Through mode, the AC Source connected to the unit's AC input is passed through to the AC Output (load).

Wiring block diagram of the Inverter-Charger

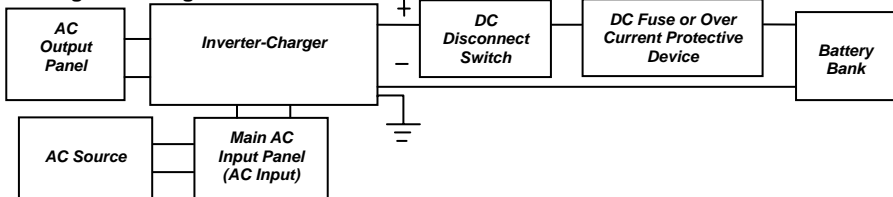

Battery Bank:

DANGER: FIRE hazard!

IC1220100 and IC1230150 are 12V system and a 12V battery bank is required. IC244090i is 24V system and a 24V battery bank is required. Using the 24V battery bank on 12V system will damage the unit and may cause fire or explosion.

- The use of a deep cycle battery is highly recommended for power inverter application.
- For battery size, you need to identify what you wish to operate, and for how long. It is recommended that you purchase as much battery capacity as possible. See more on Battery Run Time in Section 4.

DC Cable:

- All DC cables used require insulated multi-strand low resistance cable.
- The DC cables must be copper and must be rated 105°C minimum.
- 2000W unit (IC1220100), use minimum 2/0 AWG wire with maximum cable length of 5 feet.
- 3000W unit (IC1230150), use minimum 4/0 AWG wire with maximum cable length of 5 feet.
- 4000W unit (IC244090i), use maximum 2/0 AWG wire with maximum cable length of 5 feet.

Important: Use of smaller gauge cable or longer cable length may cause the inverter to shutdown under heavy load and may also melt the cable insulation and catch fire and can result in death or serious injury.

Important: Field wiring DC terminals tightening torque: 12-13.2 Nm.

Grounding Cable Size:

- For Marine application, the DC grounding cable size may be one size smaller than the minimum size conductor required for the DC current carrying conductors, providing the overcurrent protection device in the DC positive conductor is rated no greater than 135% of the capacity of the DC grounding conductor, and the conductor is no smaller than #16AWG.
- For Recreational Vehicle or caravan application, the unit has to be grounded to the vehicle chassis with a minimum #8 AWG copper conductor with either green insulator or bare wire.

Important: The unit is grounded through the ground stud of the unit.

DC Fuse or Over Current Protective Device:

Important: The unit is grounded through the ground stud located near the DC input terminal

and the chassis of the unit has to be ground properly before use.

- A DC-rated fuse or a DC-rated over-current protective device connected along the DC positive line is required.
- Based on the National Electrical Code requirement, a fuse or circuit breaker with a minimum of 300 ADC is required for IC1220100 and IC244090i, 450 ADC is required for IC 1230150.
- Based on the size of your Battery Bank, determine the overall short circuit current rating of the battery bank from the battery manufacturer. The fuse or circuit breaker chosen must be able to withstand the short circuit current that may be generated by the battery bank.
- For Marine application, the over current protective device needs to be installed within 7 inches (17.8cm) from the battery positive terminals.

DC Disconnect Switch:

- Select a DC Disconnect Switch with the same or higher rating of the selected fuse or over current protective device.
- The DC Disconnect Switch is used to disconnect the DC power between the unit and the battery bank during service, maintenance or trouble shooting.

Main AC Input Panel (wire size and breaker size):

2000W unit (IC1220100):

- Standard AC Input wire #10 AWG is required for all the AC Connections between the AC Source & the AC Input port, and #10 AWG is required for the AC output port to load.
- A 30A branch circuit breaker is also required to connect between AC Input source and unit's AC Input port.

3000W unit (IC1230150):

- For Dual AC Input, #6 AWG AC Input wire is required.
- For Split Phase AC Input, #10 AWG AC Input Wire is required for all the AC connections between the AC Source and the AC Input port.
- The AC input line must be provided with an overcurrent protection device for which a 30A branch circuit breaker is required to connect each AC Line to the unit's AC Input.

Important: Follow the electrical and/or building code when you connect the unit to any AC Source

4000W unit (IC244090i):

- Standard AC Input wire #14 AWG is required for all the AC Connections between the AC Source & the AC Input port, and the AC output port to load.
- A 20A branch circuit breaker is also required to connect between AC Input source and unit's AC Input port.

Important: Follow the electrical and/or building code when you connect the unit to any AC Source.

Inverter AC Output Panel (wire size and breaker size):

2000W, 3000W unit (IC1220100, IC1230150):

- For 3000W model (IC1230150), #10 AWG wire is required for all AC Output connections based on the full 30A pass-through rating.
- For 2000W model (IC1220100), #12 AWG wire is required for all AC Output connections based on the 20A AC Output breaker used on the unit.
- To meet CSA, UL and electrical code requirements and to protect system wiring, the AC output line must be provided with an overcurrent protection device for which a maximum 20A or 30A branch circuit breaker is required to connect each AC Output Line to the unit's AC Output. If an AC Output wire of smaller than 10 AWG is used, then the overcurrent protection device will have to be smaller. Follow the electrical and or building code to choose your protection device rating.

4000W unit (IC244090i):

- #12 AWG wire is required for all AC Output connections based on the full 20A pass-through rating between the unit and the AC Inverter AC Panel.
- To meet electrical code requirements and to protect system wiring, the AC output line must be provided with an overcurrent protection device for which a maximum 20A branch circuit breaker is required to connect each AC Output Line to the unit's AC Output. If an

AC Output wire of smaller than #12 AWG is used, then the overcurrent protection device will have to be smaller. Follow the electrical and or building code to choose your protection device rating.

Installing the Inverter-Charger System

WARNING: Electrical Shock Hazard

The unit 'On/Off' switch does not disconnect the DC power from the battery. Use the DC Disconnect Switch or disconnect the DC input cable connection to disconnect the DC power from the battery before working on any circuits connected to the unit. Use the AC circuit breaker to disconnect any AC power to the unit before servicing. Failure to follow these instructions can result in death or serious injury.

Installation:

- Choose an appropriate mounting location. The unit should be installed away from the battery in a separate well ventilated compartment. Do not install the unit in any compartment containing flammable gases or liquids like gasoline or in the battery compartment where they may be explosive hydrogen gas from the batteries present.
- The length and size of the DC cables will affect unit performance.
- For indoor use, the unit can be mounted in any direction except with the fan panel (panel with fan opening) facing upwards or downwards.
- The location to install the unit has to have a normal air temperature between 0°C – 60°C (32°F-140°F). The cooler the better, or overheating may result.
- Use the mounting template below to mark the positions of the mounting screws.
- Drill the 4 mounting holes and place the Inverter-Charger in position and fasten the unit to the mounting surface.

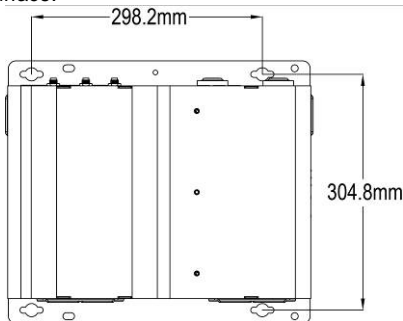

AC Input Wire Connection:

DANGER: Make sure all the AC wiring being connected to the unit is physically disconnected or by opening the circuit breaker from the electrical sources. All wiring must be done in accordance with local and national electrical wiring codes. Please double check the location of the AC Input located inside the wiring compartment. Misconnecting to the AC Input port inside the same compartment will blow the unit and may catch fire.

- The AC and DC wire cannot be mixed together in the same conduit.
- The AC Input and AC output wire should be separated out through the two AC knockouts located below the AC wiring compartment opening.
- Remove AC compartment cover by unscrewing the four screws located on the four corners of the AC compartment cover.
- There are two ground bus locations inside the AC Wiring Compartment. The ground bus located at the left hand side of the AC compartment is intended for use with AC Input ground wire. The right hand side ground bus is intended for use with AC Output ground wire.
- Remove the left hand side AC knockout. Install the strain-relief clamp in the AC knockout.
- Run the AC input wire(S) through the strain relief clamp.
- Connect the AC Input line and neutral wires to the AC Input terminals as follows:

AC Input Terminals	2000W (IC1220100)	3000W (IC1230150)		4000W(IC2444090i)
	Single Input	Dual Input	Split Phase Input	Single Input
N	Neutral	Neutral	Neutral	Neutral
L	Line	Not Applicable	Not Applicable	Line
L1	Not Applicable	Line 1	Line 1	Not Applicable
L2	Not Applicable	Line 2	Line 2	Not Applicable

- Connect AC Input wire Ground to “AC GND” bus.
- Secure the strain-relief clamp.

AC Output Wire Connection:

- Remove the right hand side AC knockout. Install the strain-relief clamp in the AC knockout.
- Run the AC output wire through the strain relief clamp.
- Connect the AC Output line and neutral wires to the AC Output terminals as follows:

AC Output Terminals	2000W (IC1220100)	3000W (IC1230150)		4000W (IC2444090i)
	Single Output	Dual Output	Split Phase Output	Single Output
N1	Not Applicable	Neutral 1	Neutral	Not Applicable
L1	Not Applicable	Line 1	Line	Not Applicable
L2	Not Applicable	Line 2	Not used	Not Applicable
N2	Not Applicable	Neutral 2	Not Applicable	Not Applicable
L	Line	Not Applicable	Not Applicable	Line
N	Neutral	Not Applicable	Not Applicable	Neutral

- Connect the AC Output wire Ground to “AC GND” bus.
- Secure the strain relief clamp.
- Place the AC compartment cover and secure with the four screws.

Unit Chassis Grounding Connection:

DANGER: The unit chassis has to be grounded properly. Never operate the Inverter-Charger without proper grounding. Failure to do so may result in death or serious injury.

- Connect the grounding cable’s ring terminal to the unit ground screw.
- Connect the other side of the cable to the common grounding point.

DC Input Connection:

CAUTION: Reversing the DC Input terminal will damage the unit and it cannot be repaired. Damage caused by reverse polarity connection is not covered by the warranty.

- Connect one end of the negative DC input cable to the Inverter-Charger DC negative terminal. Connect the other end of the negative DC input cable to the battery negative terminal.
- Make sure the DC Disconnect Switch is in the OFF position.
- Connect one end of the positive DC input cable to the Inverter-Charger DC positive terminal. Connect the other end of the positive DC input cable to one of the terminals of the DC Disconnect Switch.
- Connect a DC input cable between the other terminal of the DC Disconnect Switch and one side of the terminal of the fuse holder.
- Connect a DC input cable between the other terminal of the fuse holder and the battery positive terminal.
- Install the selected fuse to the fuse holder.
- Turn DC Disconnect Switch to ON position.

Remote Display Panel Connection:

- Install the RJ45 cable to your desired location.
- Connect one end of the RJ45 cable to one of the two Remote 1 or 2 port on the unit and the other end of the cable to the Remote Display Panel. Please note the polarity.

Optional Battery Temperature Sensor Connection:

- Insert the RJ45 plug from the Battery Temperature Sensors to the Cable Battery Temperature Sensor port on the unit. Please note the polarity
- Select the battery for which you would like to monitor the temperature, connect the Battery Temperature Sensor to the negative terminals of this battery.

Test the Installation:

- Switch DC disconnect switch and all AC circuit breaker to ON to provide DC and AC power to the unit. Press and hold the “Power” button for 1 second on either the. Main unit or the Remote

Display Panel to turn unit ON.

- The LED on either the Main unit or the Remote Display Panel will turn on. If AC input source is available, 'Charging' green LED turns On. This indicates the unit is running in by-pass mode meaning AC output is running from the AC input source.
- Disconnecting the AC input source by turning OFF the branch breaker. 'Battery Power' green LED will turn On. This indicates the unit is running in battery power mode.
- Plug in a small AC load like a 40W table lamp or small appliance to the AC socket to verify AC is available.
- Press and hold the "Power" button again to turn unit OFF.
- The unit is successfully installed and functioning properly.

4. UNIT OPERATION

Mode of Operation

Auto Backup Mode (Factory Default Setting)

The unit is fully automatic. When utility power is available, the unit is running in AC bypass mode. AC output is supplied from the utility. The internal AC charger is ON and will automatically top up the battery bank that is connected to the unit. When there is a power failure from the utility or an AC Source is not available, the unit will run on battery power and the unit will generate sinewave AC output to maintain and operate the load continuously.

Factory Default Setting			
Setting	2000W (IC1220100)	3000W (IC1230150)	4000W (IC244090i)
Inverter	On	On	On
SCR set	30A	30A	20A
Power Save	Off	Off	Off
Battery Type	AGM	AGM	AGM
Set Current	100A / 12V	150A / 12V	90A / 24V
EQ Mode	Off	Off	Off
Fault Alarm	On	On	On
Display Background Brightness	80%	80%	80%
Background Light Timer	3 minutes	3 minutes	3 minutes

Non-Backup Mode

Same as Auto Backup Mode but when there is a power failure of the utility or the AC input source is not available; the inverter will not turn on automatically. You are required to manually turn on the inverter. This setting is the same as factory default but with Inverter set to OFF.

Understanding the Display Functions



LED Indicator functions on unit display and remote display:

Status	Display	Function/Status
Battery Power	Green LED ON (solid)	Battery Power Mode. Remote LCD Display shows: - Battery DC Voltage and Current - Inverter AC Output Voltage and Current e.g. DC: 12.5V 30A AC: 120V 2.7A or DC: 25.0V 15A AC: 230V 1.4A Press '+' or '-' key to check AC Output Power. e.g. System Power 0.33 KW

Charging	Green LED ON (solid)	Pass-Through Mode. Battery is fully charged. Remote LCD Display shows: - AC Input Voltage and Current - Battery DC Voltage and charging current e.g. AC: 120V 15A DC: 12.0V 5A or AC: 230V 7.8A AC: 24.0V 2.5A Press '+' or '-' key to check charging stage. e.g. Charge Stage Float Press '+' or '-' key to check AC Input Power. e.g. System Power 1.80 KW
	Green LED ON (flashing)	Pass-Through Mode (AC mode). Battery Charging is in progress. Remote LCD Display shows: - Battery DC Voltage and charging current - AC Input Voltage and Current e.g. AC: 120V 20A DC: 12.0V 50A or AC: 230V 10.4A DC: 25.0V 25A Press '+' or '-' key to check charging stage. e.g. Charge Stage ABS Press '+' or '-' key to check AC Input Power. e.g. System Power 2.4 KW
Fault	Red ON (solid)	Unit has shutdown. Display shows error code and error message. - Low battery shutdown e.g. FAULT: E01 Low Battery

Push Button Functions on Unit

Function	
Power	Turns unit On/Off. Press and hold for 1 second to Remote Display unit On/Off
Reset	Reset the unit: Press once to reset the unit. This may be required when an error is detected on the unit

Push Button Functions on Remote Display

A beeping sound will occur every time any button on the unit is triggered.

Function	
O	Turns On/Off. Press and hold for 2 seconds to turn unit On/Off. Display shows unit Inverter power level and revision. e.g. Inverter/Charger 3000W REV 1.8
Enter	Save the selected setting or go to the next stage
+	Scroll up on the menu
-	Scroll down on the menu
EXIT	Exiting or entering the feature setting mode

Understanding the Charger Functions

Three-Stage Charging:

The Three-Stage Charging algorithm has a Bulk, then Absorption and then Float sequence. During the Bulk stage, the battery accepts the maximum constant current from the charger. In the Absorption stage, the battery voltage is held to constant voltage and the charging current will slowly reduce. In Float stage, the charger continuously produces voltage at a lower level to fully top up the battery and maintain the battery in a fully charged state.

The charger will automatically restart the charging cycle in Bulk stage if the battery is discharged to 12.5V on 12V model IC 1230150, IC 1220100, or 24V model IC 244090i. Also, after seven days, the charger will automatically restart the recharging cycle to refresh the battery.

Battery Type:

Three types of battery setting (GEL, AGM and Flooded) are available. See reference battery charging voltage as shown:

2000W, 3000W unit (12V model: IC1220100, IC1230150):

Battery Type	Absorption	Float	Equalization
GEL	14.4 V	13.8 V	N.A.
AGM	14.3 V	13.45 V	N.A.
Flooded	14.4 V	13.5 V	16.0 V

4000W unit (24V model: IC244090i):

Battery Type	Absorption	Float	Equalization
GEL	28.8 V	27.6 V	N.A.
AGM	28.6 V	26.9 V	N.A.
Flooded	28.8 V	27.0 V	32 V

Equalize the Flooded Battery:

For Flooded battery type, equalization mode is available. Use the following procedure to equalize the flooded battery. See also section 5 on setting EQ mode for flooded battery.

DANGER: Explosion Hazard. The flooded battery generates explosive gases during equalization. Follow all the battery safety precautions listed in the manual.

CAUTION: Risk of Battery and Equipment damage. Only a Flooded lead-acid battery can be equalized. Consult your battery manufacturer or read the battery manual when you try to equalize your batteries. Disconnect any DC load connected to the battery, as during equalization mode, the charger will produce 16V for 2000W, 3000W unit (IC 1220100, IC1230150) or 32V for 4000W unit (IC 244090i) to the batteries that may damage some of the DC load connected to the battery. You must monitor the battery specific gravity throughout the equalization to determine the end of the equalization cycle.

When EQ mode is set to ON, the unit will charge batteries in one full cycle before it starts to equalize the battery. Check the battery electrolyte level. If necessary, refill with distilled water only. All cells should have similar electrolyte levels. If distilled water is added, batteries must undergo a complete charge cycle. The charger cannot determine when to terminate the equalization of the battery. A 1 hour time-out is intended as a safety feature to terminate the equalizing process. You can re-activate the EQ mode by setting it ON again as necessary after checking batteries manually.

Optional Battery Temperature Sensor Feature:

Optional Battery Temperature Sensor **Part Number #BTS-10K** is highly recommended to be used with the charger to protect your battery and provide better charging voltage accuracy. The battery temperature sensor senses the battery temperature and makes adjustments to the charging voltage.

2000W, 3000W unit (IC1220100, IC1230150):

Battery Temperature	Battery Charging Voltage Adjustment from 25 °C normal setting	
	Flooded and GEL type	AGM type
< 25 °C	+ 0.027 V /°C	+ 0.021 V /°C
25 °C	0 V	0 V
> 25 °C	- 0.027 V /°C	- 0.021 V /°C

4000W (IC 244090i) unit:

Battery Temperature	Battery Charging Voltage Adjustment from 25 °C normal setting	
	Flooded and GEL type	AGM type
< 25 °C	+ 0.054 V /°C	+ 0.042 V /°C
25 °C	0 V	0 V
> 25 °C	- 0.054 V /°C	- 0.042 V /°C

Note: The charger will terminate battery charging when the Sensor senses the battery temperature reaching 60 °C. It will not continuously make voltage adjustments when the battery temperature drops to below 0 °C.

Understanding the Error Codes

Error Code on Display	Condition	Corrective Action
Fault: E01 Low Battery	Battery voltage is too low and unit has shutdown	Recharge battery immediately and restart unit.
Fault: E02 High Battery	Battery voltage is too high and unit has shutdown	Check battery voltage or determine if any external charger with high voltage output is connected to the battery bank
Fault: E03 Temp Protect	Internal temperature is too high and unit has shutdown	Check if any object has blocked the air flow of the unit. Check environmental temperature. The unit will restart when the internal temperature has reduced to about 50 °C.
Fault: E04 AC Over Load	Inverter AC Output has overload	Check AC load connected and restart the unit.
Fault: E05 Short Protect	Inverter output is short circuited and has shutdown	Check load connected to the AC output and restart the unit.
Fault: E06 INV Over Load	Inverter output voltage is too high or too low and has shutdown	Check unit and load and restart the unit.
Fault: E08 BTS Protect	Battery temperature is high and warning occurs. Unit will shutdown shortly.	Check battery. Check ventilation in battery compartment. Check environmental temperature.

Estimated Run Times

Following run times are estimates for reference, based on using different battery bank sizes. Actual run times may vary.

2000W, 3000W unit (IC1220100, IC1230150):

AC Load	Estimate run time on different 12V Battery Bank Size				
	60AH	120AH	180AH	240AH	300AH
50 W	11 hrs.	22 hrs.	33 hrs.	44 hrs.	55 hrs.
100 W	5 hrs.	11.5 hrs.	17 hrs.	23 hrs.	29 hrs.
200 W	2.5 hrs.	5 hrs.	8 hrs.	11 hrs.	13.5 hrs.
500 W	49 mins	2 hrs.	3 hrs.	4 hrs.	5 hrs.
1000 W	15 mins	49 mins	1.5 hrs.	2 hrs.	2.5 hrs.
1500 W	8 mins	27 mins	49 mins	1 hr	1.5 hrs
2000 W	N.R.	15 mins	34 mins	49 mins	1 hrs
2500 W	N.R.	11 mins	25 mins	37 mins	49 mins
3000 W	N.R.	N.R.	17 mins	27 mins	37 mins

Note: N.R. – Not Recommended

4000W unit (IC 244090i):

AC Load	Estimate run time on different 24V Battery Bank Size				
	30AH	60AH	90AH	120AH	150AH
50 W	11 hrs.	22 hrs.	33 hrs.	44 hrs.	55 hrs.
100 W	5 hrs.	11.5 hrs.	17 hrs.	23 hrs.	29 hrs.
200 W	2.5 hrs.	5 hrs.	8 hrs.	11 hrs.	13.5 hrs.
500 W	49 mins	2 hrs.	3 hrs.	4 hrs.	5 hrs.
1000 W	15 mins	49 mins	1.5 hrs.	2 hrs.	2.5 hrs.
1500 W	8 mins	27 mins	49 mins	1 hr	1.5 hrs
2000 W	N.R.	15 mins	34 mins	49 mins	1 hrs
2500 W	N.R.	11 mins	25 mins	37 mins	49 mins
3000 W	N.R.	N.R.	17 mins	27 mins	37 mins

Note: N.R. – Not Recommended

5. FEATURE SETTING

To understand more about the unit features, read the following section and follow the instructions to make changes to the desired setting.

Feature Menu for Unit Setting

To enter feature setting mode, on remote display, press and hold 'EXIT' button for 5 seconds. The feature setting menu will display on the screen with the following sequence:

Menu Sequence	Setting	Function
Charger	On/Off	Turns Battery Charger On/Off
Inverter	On/Off	Turns Power Inverter On/Off
SCR set	15, 20, 25, 30 A (IC1220100, IC1230150) 10, 15, 20A (IC244090i)	Set AC Input Source Power Breaker Rating. During by-pass mode with high demand for AC power for the load, the charger current is reduced automatically to prevent the tripping of the AC Source power breaker.
Power Save	0, 5, 10, 15, 20, 50W	Turns Inverter OFF when low power loads are connected to inverter. This is used to reduce total power draw from the battery bank.
Battery Type	AGM, GEL, Flooded	Select battery type
Set Current	IC1220100, IC1230150 (60 – 150A, 5A step) IC 244090i (30 – 90A, 5A step)	Set charger current
EQ Mode (Flooded battery type use only)	On/Off	EQ mode is used to equalize the flooded battery. The charging voltage is 16V for 12V model (IC 1220100, IC 1230150 or 32V for 24V model (IC 244090i) and the current is set to half the set bulk current for 1 hour (Min: 30A, Max: 75A for IC 1220100 and IC 1230150 or Min: 15A, Max 45A for IC 244090i).
Fault Alarm	On/Off	Silent mode: Enable or Disable the audible alarm when warning or fault occur
Brightness	10-100% (10% step)	Set LCD Background lighting brightness
Backlight Timer	1–9 mins (1 min step)	Set timer ON for LCD background lighting

Use the '+' and '-' button to scroll between feature setting menu.

Press 'ENTER' button to go to the selected feature and you can now make changes on the

selected feature to your desired setting.

Use the '+' and '-' button to scroll between different set values or setting. Once the desired values or setting is chosen, press 'ENTER' button to save the setting or press 'EXIT' button to quit the setting without saving.

6. TROUBLESHOOTING

To troubleshoot the unit, please note the error code displayed on the main unit and review "Understanding the Error Codes" in section 4.

Problem	Symptom	Solution
<i>Condition: Inverter setting is set to Off, AC input source is available</i>		
No AC Output. Charging LED is off.	Unit is turned Off	Turn unit ON by following the instruction in Section 4
	AC input source is not available	Check AC input source. Check AC input branch breaker is off Check AC connection between the AC Source and the unit
	AC Input breaker is turned off or tripped	Check AC Load and reset AC Input breaker
	No DC power to unit or Battery voltage is low <7Vdc for (IC 1220100 & IC 1230150) <12Vdc for (IC 244090i)	Check DC fuse, DC Disconnect switch (if installed) and check if Branch breaker is either blown or turned OFF Use a separate charger to boost battery voltage to above 7V for 12V model or-12V for 24V model and unit can be restarted.
No AC output. Fault LED is on	AC Output breaker is tripped and check fault code	Check load and reset the AC breaker and verify the error condition and make correction.
<i>Condition: Inverter setting is set to On, AC Source is not available</i>		
No AC Output. Battery Power LED is off	Unit is turned Off	Turn unit ON by following the instruction as in Section 4
	No DC power to unit or Battery voltage is low	Check DC fuse, DC Disconnect switch (if installed) and check if Branch breaker is either blown or turned OFF Use a separate charger to boost battery voltage to above 7V for 12V model (IC 1220100 and IC 1230150) or 14V for 24V model (IC 244090i) and unit can be restarted.
No AC Output. Battery Power LED is on	AC breaker connected between the Unit AC Output to load is turn off or tripped	Check load, switch on or reset breaker
	Check AC Load Sense setting. AC Output power consumption is lower than the AC Load	Turn off AC load Sense features Decrease AC load sense power level or increase AC load connected to AC Output.
No AC output. Fault LED is on	Check error code	Verify the error condition and make correction.

7. SPECIFICATIONS

Note: Specifications are subject to change without notice.

Specification	Abso Inverter-Charger 2000 (IC1220100)	Abso Inverter-Charger 3000 (IC1230150)	Abso Inverter-Charger 4000 (IC244090i)
Inverter			
AC Output Power (Continuous)	2000W	3000W	3500W
AC Surge Power (Peak)	4000W (5 seconds)	6000W (5 seconds)	7000W (5 seconds)
AC Output Voltage/Frequency	120 VAC / 60 Hz		230 VAC / 50 Hz
AC Output Current (Continuous)	17A	25A	17.4A
AC Output Current (Peak)	40A	80A	40A
AC Output Waveform	True Sinewave (<5%THD)		
Peak efficiency	90%		
No Load battery draw	< 3.5 A nominal, <1A with load sense		
Load Sense Setting	<100W (user selectable)		
DC Input Voltage (nominal)	12.5VDC		25.0VDC
DC Input Voltage Operating Range	10.5 – 16.5VDC		21 – 33VDC
DC Input Under Voltage Alarm	11.5VDC		22.5VDC
DC Input Under Voltage Alarm Reset	12.0VDC		24.0VDC
DC Input Under Voltage Shutdown	10.5VDC		21.0VDC
DC Input Under Voltage Shutdown Reset	11.5VDC		23.0VDC
DC Input Over Voltage Shutdown	16.5VDC		33.0VDC
DC Input Over Voltage Shutdown Reset	15.0VDC		30.0VDC
Charger			
Charger Voltage Range	14.2 – 16.0VDC		28.4 – 32.0VDC
Float Voltage Range	13.4 – 13.8VDC		26.8 – 27.6VDC
Equalize Voltage (Flooded Battery)	16.0VDC		32.0VDC
Charger current (Maximum)	100A	150A	90A
Charger Control	Three stages (Bulk/Absorption/Float) with manual equalize		
Battery Type	Gel, Flooded, AGM, Lithium		
AC Input Voltage/Frequency	120 VAC / 60Hz		230 VAC / 50Hz
Efficiency	>85%		
Dead Battery Charging	>7 VDC		>12 VDC
Display			
Display Panel	External, connect through Remote 1 & 2 port		
Warning and Fault Code	E01 – E08		
AC Transfer Switch			
Transfer time	<20 ms		
Transfer Relay (Rating)	Hardwire Heavy Duty Connector		
AC Input Source Current Setting	15,20,25,30A		10,15,20A
Operating Temperature			
Storage Range	-40° to 70°C (40° to 158°F)		
Operating Range	-20 to 60°C (-4 to 140°F)		
Regulatory Compliance			
Approval	Safety		EMC
ETL/FCC	UL458, CSA C22.2 No.107.1		FCC part 15, Subpart B, Class B
CE	EN/IEC 62040-1& IEC 61558-2-16		EN/IEC 62040-2 category C2

8. WARRANTY

One Year Limited Warranty

The limited warranty program is the only one that applies to this unit, and it sets forth all the responsibilities of KISAE. There is no other warranty, other than those described herein. Any implied warranty of merchantability of fitness for a particular purpose on this unit is limited in duration to the duration of this warranty.

This unit is warranted, to the original purchaser only, to be free of defects in materials and workmanship for one year from the date of purchase without additional charge. The warranty does not extend to subsequent purchasers or users.

Manufacturer will not be responsible for any amount of damage in excess of the retail purchase price of the unit under any circumstances. Incidental and consequential damages are specifically excluded from coverage under this warranty.

This unit is not intended for commercial use. This warranty does not apply to damage to units from misuse or incorrect installation/connection. Misuse includes wiring or connecting to improper polarity power sources.

RETURN/REPAIR POLICY:

If you are experiencing any problems with your unit, please contact our customer service department at info@kisaetechnology.com or Phone 1-877-897-5778 before returning product to retail store. After speaking to a customer service representative, if products are deemed non-working or malfunctioning, the product may be returned to the purchasing store within 30 days of original purchase. Any defective unit that is returned to manufacturer within 30 days of the date of purchase will be replaced free of charge.

If such a unit is returned more than 30 days but less than one year from the purchase date, manufacturer will repair the unit or, at its option, replace it, free of charge. If the unit is repaired, new or reconditioned replacement parts may be used, at manufacturer's option. A unit may be replaced with a new or reconditioned unit of the same or comparable design. The repaired or replaced unit will then be warranted under these terms for the remainder of the warranty period. The customer is responsible for the shipping charges on all returned items.

LIMITATIONS:

This warranty does not cover accessories, such as adapters and batteries, damage or defects result from normal wear and tear (including chips, scratches, abrasions, discoloration or fading due to usage or exposure to sunlight), accidents, damage during shipping to our service facility, alterations, unauthorized use or repair, neglect, misuse, abuse, failure to follow instructions for care and maintenance, fire and flood.

If your problem is not covered by his warranty, call our Customer Service Department at info@kisaetechnology.com or 1-877-897-5778 for general information if applicable.